

Product information sheet SUPRA 450-U

Item no. 452614

Benefits



- Wide programme with various combination options
- For individual configuration of main and additional bowl and accessories
- Optimum position of outlet and overflow
- Undermount installation

Planning information

- Corner radius: 60mm
- Cut out information supplied with bowls.
- Cut out CNC files also available on www.blanco.co.uk for download.

Scope of supply

- Undermount bowl with 3 ½" basket strainer waste
- overflow and waste
- fixing kit included

Details

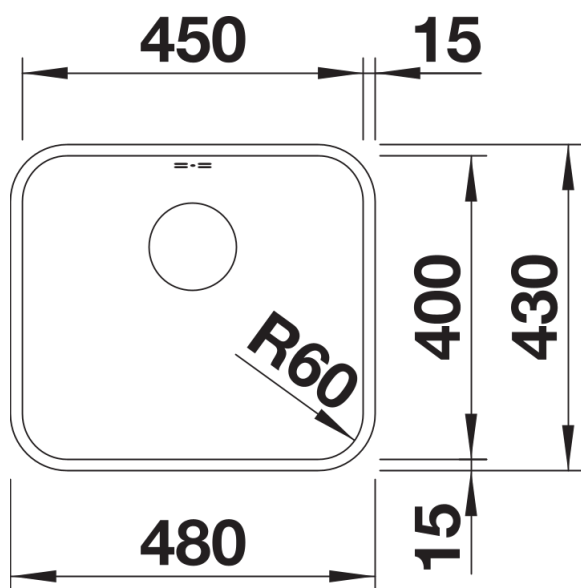

Top view

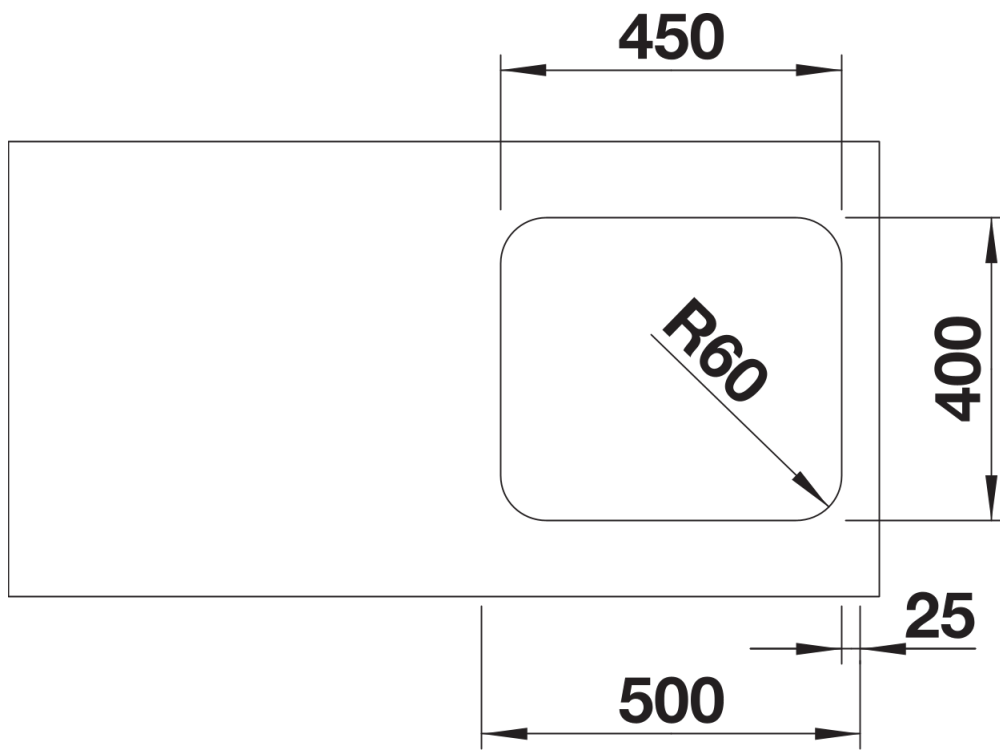

Cut-out

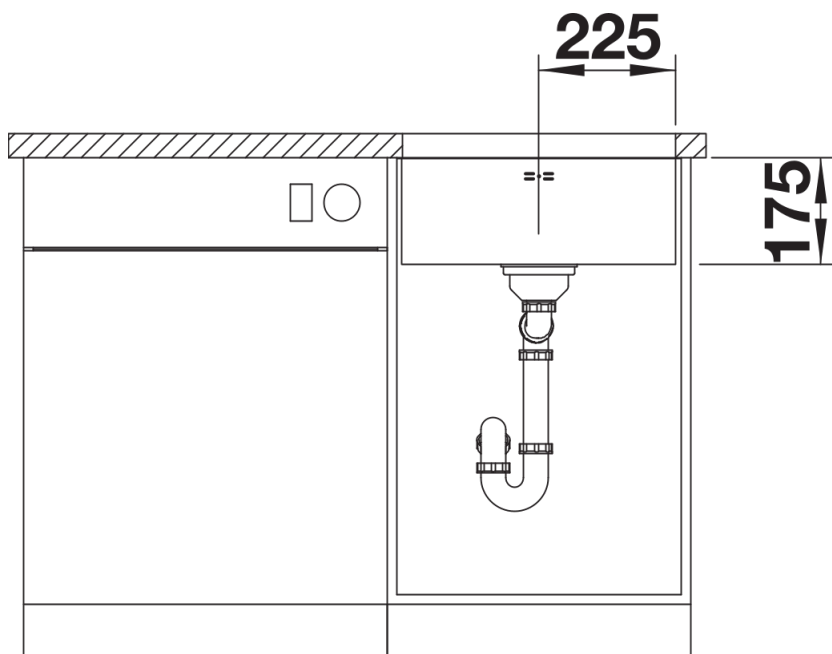

Front view

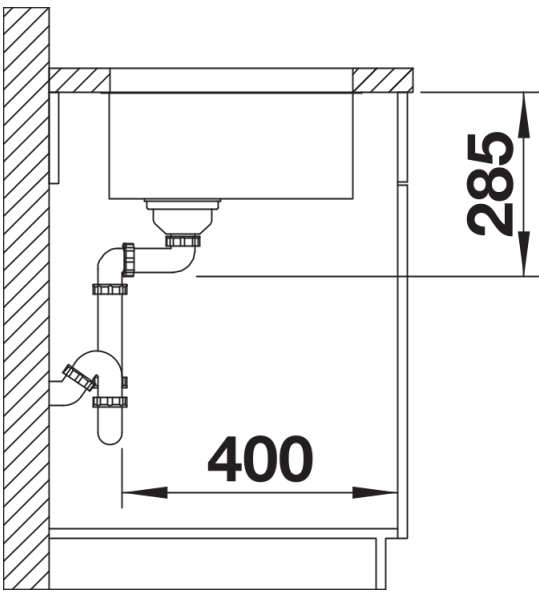

Side view